

## Review of Tuning Methods of DMC and Performance Evaluation with PID Algorithms on a FOPDT Model

R D Kokate<sup>1</sup> and L M Waghmare<sup>2</sup>

<sup>1</sup> *Research scholar, Shri. Guru Gobind Singhji,*

<sup>2</sup> *Shri. Guru Gobind Singhji*

*Institute of Engineering and Technology, Department of Instrumentation  
Engineering,Nanded, Maharashtra (India).*

*rd\_kokate@yahoo.co.in, lmwaghmare@yahoo.com*

### **Abstract**

*In this paper we have revived and proposed tuning strategy for SISO Dynamic matrix control (DMC). The tuning strategy achieves set point tracking with minimal overshoot and modest manipulated input move sizes and is applicable to a broad class of open loop stable processes. The simulation of a simple FOPDT model is carried out using advanced control algorithms, specifically these advanced algorithms are the DMC, IMC-based PID controller, and their performance is compared with PID Controller which is tuned using Z-N tuning method.*

**Keywords:** *Tuning, FOPDT,IMC,DMC),PID.*

### **1. Introduction**

We know that the most popular control algorithm used in industry is the PID controller which has been implemented successfully in various technical fields. However, since the evolution of computers during the 1980s a number of modern and advanced control algorithms have been also developed and applied in a wide range of industrial and chemical applications. Some of them are the Internal Model based PID controller, the Model Predictive controller, the common characteristic of the above algorithms is the presence of the controller structure. The purpose of this paper is to apply these advanced algorithms to a linear first order plus delay time (FOPDT) process model and compare their step response with the conventional PID and IMC based PID controller.

Initially, we presented a brief discussion over the theoretical designing aspects of each applied algorithm. The main section of the paper is devoted to the simulation results in terms of type 1 servomechanism performance of a simple FOPDT process, using the above control algorithms in various practical scenarios. The primary benefit of a FOPDT model approximation is that it permits derivation of a compact analytical expression for computing  $\lambda$  (Move suppression coefficient) and adding the  $Q$  in DMC, although a FOPDT model approximation does not capture all the features of some higher-order processes, it often reasonably describes the process gain, overall time constant, and effective dead time of such processes. In the past, tuning strategies based on a FOPDT model such as Cohen-Coon, IAE, and ITAE have proved useful for PID implementations. The tuning strategy reviewed here is significant because it offers an analogous approach for DMC.

The different sections in this paper are organized as (2) Introduction of MPC (3) Review of the DMC and Formulation of DMC (4) IMC-PID controller (5) Example and simulation experiment (6) conclusion (7) References.

## 2. Model Predictive Control

Model predictive control (MPC) has established itself over the past decade as an industrially important form of advanced control. Since the seminal publication of Model Predictive Heuristic Control (later Model Algorithmic Control) [37] and Dynamic Matrix Control [9-10], MPC has gained widespread acceptance in academia and in industry. Several excellent technical reviews of MPC recount the significant contributions in the past decade and detail the role of MPC from an academic perspective [15], [28], [37], [29] (and from an industrial perspective, [3], [4], [33] [35]).

MPC refers to a family of controllers that employs a distinctly identifiable model of the process to predict its future behavior over an extended prediction horizon. A performance objective to be minimized is defined over the prediction horizon, usually as a sum of quadratic set point tracking error and control effort terms. This cost function is minimized by evaluating a profile of manipulated input moves to be implemented at successive sampling instants over the control horizon. Closed loop optimal feedback is achieved by implementing only the first manipulated input move and repeating the complete sequence of steps at the subsequent sample time. This is “moving horizon” concept of MPC, where the controller looks a finite time into the future, is illustrated in Fig 1.

Dynamic matrix control is arguably the most popular MPC algorithm currently used in the chemical process industry. [34] reported about 600 successful applications of DMC. It is not surprising why DMC, one of the earliest formulations of MPC, represents the industry’s standard today. A large part of DMC’s appeal is drawn from an intuitive use of a finite step response (or convolution) model of the process, a quadratic performance objective over a finite prediction horizon, and optimal manipulated input moves computed as the solution to a least squares problem. Because of its popularity, this work focuses on an overall tuning strategy for DMC.

Another form of MPC that has rapidly gained acceptance in the control community is Generalized Predictive Control (GPC) [6], [7]. It differs from DMC in that it employs a controlled autoregressive and integrated moving average (CARIMA) model of the process which allows a rigorous mathematical treatment of the predictive control paradigm. The GPC performance objective is very similar to that of DMC but is minimized via recursion on the Diophantine identity [6],[7], [18]. Nevertheless, GPC reduces to the DMC algorithm when the weighting polynomial that modifies the predicted output trajectory is assumed to be unity [26]. Therefore, without any loss of generality, the tuning strategy proposed in this paper is directly applicable to GPC.

Engineers at Shell Oil developed their own independent MPC technology in the early 1970s, with an initial application in 1973. In [10] presented details of an unconstrained multivariable control algorithm which they named dynamic matrix control (DMC) in the [9], [10]. In a companion paper,[31] described an application of DMC technology to an FCCU reactor/regenerator in which the algorithm was modified to handle nonlinearities and constraints. Neither paper discussed their process identification technology.

Key features of the DMC control algorithm include the following:

1. Linear step response model for the plant;
2. Quadratic performance objective over a finite prediction horizon;

3. Future plant output behavior specified by trying to follow the set point as closely as possible;
4. Optimal inputs computed as the solution to a least squares problem.

The linear step response model used by the DMC algorithm relates changes in a process output to a weighted sum of past input changes, referred to as input moves. For the SISO case the step response model looks like: The move weights are the step response coefficients. Mathematically the step response can be defined as the integral of the impulse response; given one model form the other can be easily obtained. Multiple outputs were handled by superposition. By using the step response model one can write predicted future output changes as a linear combination of future input moves. The matrix that ties the two together is the so-called Dynamic Matrix. Using this representation allows the optimal move vector to be computed analytically as the solution to a least-squares problem. In practice the required matrix inverse can be computed off-line to save computation. Only the first row of the final controller gain matrix needs to be stored because only the first move needs to be computed.

The objective of a review of DMC controller is to drive the output as close to the set point as possible in a least squares sense with a penalty term on the MV moves. This results in smaller computed input moves and a less aggressive output response. As with the IDCOM reference trajectory, this technique provides a degree of robustness to model error. Move suppression factors also provide an important numerical benefit in that they can be used to directly improve the conditioning of the numerical solution. In paper [10] shows results from a furnace temperature control application to demonstrate improved control quality using the DMC algorithm In their paper [31] described an application of DMC technology to FCCU reactor/regenerator control. Four such applications were already completed. In paper [31] described additional modifications to the DMC algorithm to prevent violation of absolute input constraints. When a predicted future input came sufficiently close to an absolute constraint, an extra equation was added to the process model that would drive the input back into the feasible region. These were referred to as time variant constraints. Because the decision to add the equation had to be made on-line, the matrix inverse solution had to be recomputed at each control execution. In [31] developed a matrix tearing solution in which the original matrix inverse could be computed off-line, requiring only the matrix inverse corresponding to active time variant constraints to be computed on-line.

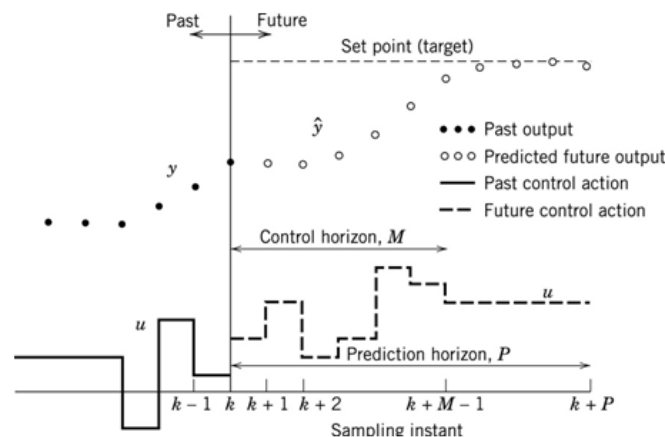

**Fig.1 Basic Control Strategy of Predictive Control.**

Its main purpose is the calculation of a controlled output sequence  $y(k)$  that tracks optimally a reference trajectory  $\hat{y}(k)$  during  $M$  present and future control moves ( $M \leq p$ ). Though  $M$  control moves are calculated at each sampled step, only the first  $\Delta u(k) = (u^0(k) - u(k))$  is implemented. At the next sampling interval, new values of the measured output are obtained. Then the control horizon is shifted forward by one step and the above computations are repeated over the prediction horizon.

### 3. Review of DMC Algorithm.

In this paper review of tuning strategy of single-input single-output (SISO) DMC algorithm [38], which is applicable to a wide range of open loop stable processes.

The DMC control law is given by,

$$u = (A^T A + \lambda I)^{-1} A^T e \quad (1)$$

Where  $A$  is the dynamic matrix,  $e$  is the vector of predicted errors over the next  $P$  sampling instants (prediction horizon),  $\lambda$  is the move suppression coefficient, and  $u$  is the manipulated input profile computed for the next  $M$  sampling instants, also called the control horizon. The  $A^T A$  matrix, to be inverted in the evaluation of the DMC control law, is referred to in this work as the system matrix. Implementation of DMC with a control horizon greater than one manipulated input move necessitates the inclusion of a move suppression coefficient  $\lambda$ . This coefficient serves a dual purpose of conditioning the system matrix before inversion and suppressing otherwise aggressive control action occurs. It is often used as the primary adjustable parameter to fine tune DMC to desirable performance.

DMC refers to a class of advanced control algorithms that compute a sequence of manipulated variables in order to optimize the future behavior of the controlled process. Initially, it has been developed to accomplish the specialized control needs in power plants and oil refineries. However because its ability to handle easily constraints and MIMO systems with transport lag, it can be used in various industrial fields.

The first predictive control algorithm is referred to the publication of [39]. However, in [9] developed their own MPC algorithm named Dynamic Matrix Control, Since then, a great variety of algorithms based on the MPC principle has been also developed. Their main difference is focused on the use of various plant models which is an important element of the computation of the predictive algorithm (i.e. step model, impulse model, state-space models, etc). The main idea of the predictive control theory is derived from the exploitation of an internal model of the actual plant, which is used to predict the future behavior of the control system over a finite time period called prediction horizon  $p$  (Fig. 1).

#### 3.1 Formulation of DMC Algorithm

The brief idea of DMC step response model is given in this section to find out the control signal given by (1). The different steps used in DMC algorithm are

1. Find out step response model of DMC and obtained system dynamic matrix  $A$  which is calculated as,

$$y(t + 1) = y_0 + \sum_{i=1}^{p-1} A_i \Delta u(k - i + 1) + A_p u(k - p + 1) \quad (2)$$

Where,  $A_i$  is the  $i$ -th step response coefficient;  $p$  is an integer (the model horizon),  $Y_0 =$  initial value at  $k=0$

$$y(t + 1) = y_0 + \sum_{i=1}^{p-1} A_i \Delta u(k - i + 1) + A_p u(k - p + 1) \quad (3)$$

The one-step-ahead prediction can be obtained from (3) by replacing  $y(k + 1)$  with the  $\hat{y}(t + 1)$

$$\hat{y}(t + 1) = y_0 + \sum_{i=1}^{p-1} A_i \Delta u(k - i + 1) + A_p u(k - p + 1) \quad (4)$$

The (4) can be expanded as

$$\hat{y}(t + 1) = A_i \Delta u(k) + \sum_{i=1}^{p-1} A_i \Delta u(k - i + 1) + A_p u(k - p + 1) \quad (5)$$

Similarly, the  $j^{\text{th}}$  step ahead prediction of above equation is given by,

$$\hat{y}(t + j) = \sum_{i=1}^j A_i \Delta u(k + j - i) + \sum_{i=j+1}^{p-1} A_i \Delta u(k - j - i) + A_p u(k + j - p) \quad (6)$$

Then defining the predicted free response from(4)

$$\hat{y}_0(t + j) = A_i \Delta u(k) + \sum_{i=j+1}^{p-1} A_i \Delta u(k - i + 1) + A_p u(k - j - p) \quad (7)$$

The required predicted relation is calculated from (6) as,

$$\hat{y}(t + j) = \sum_{i=1}^j A_i \Delta u(k + j - i) + \hat{y}_0(t + j) \quad (8)$$

The model predictions in (8) can be written as

$$y(k + 1) = A \Delta u(k) + \hat{y}_0(k + 1) + [y(k) - \hat{y}(k)]$$

$$\hat{y}(K) = A \Delta u(k) + \hat{y}_0(K + 1) \quad (9)$$

The model predictions in (9) can be written as

$$\begin{bmatrix} \hat{y}(k + 1) \\ \hat{y}(k + 1) \\ \dots \\ \hat{y}(k + M) \\ \hat{y}(k + M) \\ \dots \\ \hat{y}(k + P) \end{bmatrix} = \begin{bmatrix} a_1 & 0 & \dots & 0 \\ a_2 & a_1 & 0 & \dots \\ \dots & \dots & \dots & \dots \\ a_M & a_{M-1} & \dots & a_1 \\ a_{M+1} & a_M & \dots & a_2 \\ \dots & \dots & \dots & \dots \\ a_p & a_{p-1} & \dots & a_{p-M-1} \end{bmatrix} \begin{bmatrix} \Delta u_k \\ \Delta u_{k+1} \\ \dots \\ \Delta u_{k+M-3} \\ \Delta u_{k+M-2} \\ \dots \\ \Delta u_{k+M-1} \end{bmatrix} \quad (10)$$

Where,  $A$  is the  $P \times M$  dynamic matrix, the bias Correction of model predictions can be corrected by utilizing the latest measurement,  $y(k)$ . the corrected prediction is defined to be  $Y(t + j) = [y(k) - \hat{y}(k)]$ .

2. Define the reference trajectory which is used to make a gradual transition to the desired set point; the reference trajectory  $y_r$  can be specified in several different ways. Let the reference trajectory over the prediction horizon,  $P$  given as.

$$y_r(k + 1) = \text{col}[y_r(k + 1), y_r(k + 1), \dots, y_r(k + p)] \quad (12)$$

Where,  $y_r$  is an  $m \times P$  vector.

3. Find the control signal by minimizing the predicted deviations between the reference trajectory and actual trajectory given by,

$$\Delta u(k) = \text{col}[\Delta u(k), \Delta u(k + 1), \dots, \Delta u(k + M - 1)] \quad (13)$$

4. Defining the predicted error using

$$\hat{e}(K + 1) = y_r(k + 1) - y(k + 1) \quad (14)$$

Where,  $y(k + 1)$  is the corrected prediction, similarly the predicted unforced error.  $\hat{e}_0(K + 1)$ , is defined as

$$\hat{e}_0(K + 1) = y_r(k + 1 - \hat{y}_0(k + 1)) \quad (15)$$

The objective of the control calculations is to calculate the control policy for the next  $M$  time intervals and the objective of DMC controllers is to drive the output as close to the set points as possible in a least squares sense with the possibility of the inclusion of a penalty term of the input moves. Therefore the manipulated variable is selected to minimize a quadratic objective that can consider the minimization of future alone.

5. Calculate vector  $\Delta u(k)$ , so as to minimize the predicted errors over the prediction horizon,  $P$  and the size of the control move over the control horizon  $M$ . from a quadratic performance index

$$\min J = \hat{e}(k + 1)^T Q e(k + 1) + \Delta u(k)^T R u(k) \quad (16)$$

$\Delta u(k)$

Where  $Q$  is a positive-definite weighting matrix and  $R$  is a positive semi-definite matrix. Both  $Q$  and  $R$  are usually diagonal matrices with positive diagonal elements. The weighting matrices are used to weight the most important outputs and inputs.

6. Finally the DMC control law that minimizes the objective function, can be calculated analytically as,

$$\Delta u(k) = (A^T Q A + R)^{-1} A^T Q \hat{e}_0(K + 1) \quad (17)$$

Where,  $A$  is the dynamic matrix. This control law can be written in a more compact form

$$\Delta u(k) = K_c Q \hat{e}_0(K + 1) \quad (18)$$

Where controller gain matrix  $K_c$  is defined to be

$$K_c = (A^T Q A + R)^{-1} A^T Q \quad (19)$$

Note that  $K_c$  can be evaluated off-line, rather than on-line, provided that the dynamic matrix  $A$  and weighting matrices,  $Q$  and  $R$ , are constant. The calculation of  $K_c$  requires the inversion of  $A$  matrix the DMC control law is given by

$$\Delta u(k) = K_c \hat{e}_0(K + 1) \quad (20)$$

Where,  $\Delta u(k) = \text{col}[\Delta u(k), \Delta u(k + 1), \dots \dots \Delta u(k + M - 1)]$

Note that the controller gain matrix,  $K_c$ , is an  $M \times P$  matrix. In the receding horizon control approach, only the first step of the,  $M$ -step control policy,  $\Delta u(k)$ , is implemented.

$$\Delta u(k) = K_{cl} Q \hat{e}_0(K + 1). \quad (21)$$

The Dynamic Matrix with the move Suppression factor  $q$  added

$$Q = \begin{bmatrix} q & 0 & 0 & \dots & 0 \\ 0 & q & 0 & \dots & 0 \\ 0 & 0 & q & \dots & 1 \\ & & & \dots & \\ 0 & 0 & 0 & \dots & \dots & q \end{bmatrix} \quad A = \begin{bmatrix} A \\ Q \end{bmatrix} \quad A = \begin{bmatrix} a_1 & 0 & 0 \\ a_1 & a_2 & 0 \\ a_3 & a_2 & a_1 \\ a_3 & a_3 & a_2 \\ a_3 & a_3 & a_2 \\ q & 0 & 0 \\ 0 & q & 0 \\ 0 & 0 & q \end{bmatrix}$$

DMC Control law remains the same as before except the  $A$  now contains  $Q$

### 3.2.1. SISO DMC Tuning.

Tuning of unconstrained and constrained DMC for SISO and multivariable systems has been addressed by an array of researchers. In the past, systematic trial-and-error tuning procedures have been proposed [9], [37], [21] presented a detailed sensitivity analysis of adjustable parameters and their effects on DMC performance. The method of principal component selection was presented by [22], [24], as a method to compute an appropriate prediction horizon and a move suppression coefficient [2]. To simplify DMC tuning, [23] also proposed the “ $M$ ” controller configuration of DMC, other tuning strategies for DMC have concentrated on specific aspects such as tuning for stability [14], [25], [5], [34], and robustness is tested in [32], [19], and performance evaluated in [27], [16], [17]. Although some of the above methods provide a complete design of DMC, they also require fairly sophisticated analysis tools and an advanced knowledge of control concepts for their implementation. Hence, there still exists a need for easy-to-use tuning strategies for DMC. Tuning of unconstrained SISO DMC is challenging because of the number of adjustable parameters that affect closed-loop performance. These include the following: a finite prediction horizon,  $P$ ; a control horizon,  $M$ ; a move suppression coefficient,  $\lambda$ ; a model horizon,  $N$ ; and a sample time,  $T$ . The first problem that needs to be addressed is the selection of an appropriate set of tuning parameters from among those available for DMC. Practical limitations often restrict the availability of sample time,  $T$ , as a tuning parameter [13], [1]. The model horizon is also not an appropriate tuning parameter since truncation of the model horizon,  $N$ , misrepresents the effect of past moves in the predicted output and leads to Unpredictable closed-loop performance [2].

### 3.2.2. Unconstrained SISO DMC.

DMC does not always compete with, but sometimes complements, classical three-term PID (proportional, integral, derivative) controllers. That is, it is often implemented in advanced industrial control applications embedded in a hierarchy of control functions above a set of traditional PID loops [31], [33]. The unconstrained SISO DMC formulation considered in this work does not unleash the full power of MPC. This restricted form of DMC does not allow Multivariable control while satisfying multiple process and performance objectives. However, the analysis presented in [38] provides a foundation upon which more advanced tuning strategies may be developed. In any event, unconstrained SISO DMC does offer some useful capabilities. For example, past comparison studies between unconstrained DMC and traditional PI control [12] show that DMC provides superior performance when disturbance tuning differs significantly from servo tuning. DMC has also demonstrated superior performance in the case of plant model mismatch, except for process gain mismatch. Additionally, incorporation of process knowledge in the controller architecture provides

DMC with anticipatory capabilities and facilitates control of processes with nonminimum phase behavior and large dead times. The form of the performance objective provides a convenient way to balance set point tracking with control effort, leading to an intuitive tradeoff between performance and robustness.

### 3.2.3. Implementation of the DMC Tuning Strategy

The reviewed DMC tuning strategy is referred from [38], which includes the analytical expression for the move suppression coefficient,  $\lambda$ . This tuning strategy can be applied to unconstrained DMC in closed loop with a broad class of SISO processes that are open loop stable, including those with challenging control characteristics such as high process order, large dead time, and nonminimum phase behavior.

1. Select the identification of a first order plus dead time (FOPDT) model approximation of the process.
2. Select an appropriate sample time  $T_s$
3. Compute a model horizon,  $N$ , and a prediction horizon,  $P$ , from  $t_p$ ,  $\theta$  and  $T$  from FOPDT model [38].

It may be necessary to fine tune DMC for desired performance by altering  $P$  and  $\lambda$  from the starting values given by the tuning strategy. The recommended approach is to increase  $\lambda$  for smaller move sizes and slower output response.

### 3.2.4 Selection of DMC Parameters and Sensitivity Study

Based on the above discussion, main parameters for developing a systematic tuning strategy for DMC include the prediction horizon,  $P$ , the control horizon,  $M$ , and the move suppression coefficient, though this simplifies the task of sensitivity analysis, the appropriate choice of these parameters is strongly dependent on the sample time and the nature of the process.

Over the past decade, detailed studies of DMC parameters have provided a wealth of information about their qualitative effects on closed-loop performance [21, [11], [23]. In this section, a brief sensitivity study investigates the extent to which various parameters affect DMC performance. This study is targeted toward selection of appropriate tuning parameters for developing a DMC tuning strategy. A base case process is employed to illustrate the effect of adjustable parameters on DMC response for a step change in set point (Figures 3-6).

Fig. 3-6, each comprise a matrix of closed-loop response results for different settings of  $T$ ,  $M$ ,  $p$ ,  $\lambda$ , results are presented for sample times such that the ratio  $T/t$  is 0.1,  $M$  is selected to be either 2 or 8 manipulated input moves. The range of  $T$  and  $P$  explored corresponds to that recommended by the proposed tuning strategy. The impact of  $T$  on DMC closed-loop performance when  $P$  is held constant is shown in Fig.3 Similar comparisons between other pairs of response lead to the same conclusion. Another interesting observation can be made about the effect of  $T$  on the analytical expression for  $\lambda$ . For example response for a fixed  $M$ , as  $P$  decreases the system matrix becomes less singular and the overall magnitude of its elements decreases. Hence, a smaller  $\lambda$  is sufficient to provide the same effect as a larger  $\lambda$  with a larger prediction horizon.



#### 4. IMC-Based PID Controller

The PID control algorithm [1] is the most common feedback controller in industrial processes. It has been successfully implemented for over 50 years, as it provides satisfactory robust performance despite the varied dynamic characteristics of a process plant [40].

The proper tuning of the PID controller aims a desired behavior and performance for the controlled system and refers to the proper definition of the parameters which characterize each term. Over the past, it has been proposed several tuning methods, but the most popular is suggested by due to its simplicity [41] tuning method. This tuning method is based on the computation of a process's critical characteristics, i.e. critical gain  $K_{cr}$  and critical period  $p_{cr}$ . The internal model control (IMC) algorithm [40] is based on the fact that an accurate model of the process can lead to the design of a robust controller both in terms of stability and performance [42]. The basic IMC structure is shown in Fig. 2 and the controller representation for a step perturbation is described by (22).

$$G_f(s) = \frac{G_f(s)}{G_l(s)} \quad (22)$$

Where  $G_l(s)$  is the inverse minimum phase part of the process model and  $G_f(s)$  is a  $n^{\text{th}}$  order low pass filter  $1/(\lambda s + 1)^n$ . The filter's order is selected so that  $G_q(s)$  is semi-proper and  $\lambda$  is a tuning parameter that affects the speed of the closed loop system and its robustness [43],[44].

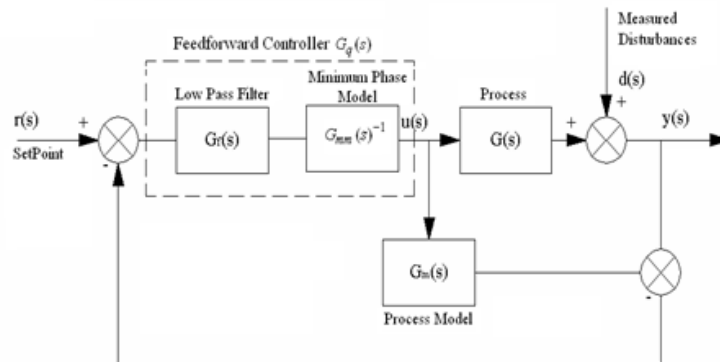

**Fig. 2 IMC Control Structure**

However, there is equivalence between the classical feedback and the IMC control structure, allowing the transformation of an IMC controller to the form of the well-known PID algorithm.

$$G_c(s) = \frac{G_q(s)}{1 - G_q(s)G_m(s)} \quad (23)$$

The resulted controller is called IMC-based PID controller and has the usual PID form (24).

$$G_c(s) = \frac{q(s)}{(1 - G_p(s)q(s))}$$

Then PID form is calculated to find the PID settings. With filter time constants

$$G_c(s) = k_c \left[ \frac{\tau_i \tau_D s^2 + 1}{\tau_i s} \right] \left[ \frac{1}{(\tau_f s + 1)} \right] \quad (24)$$

With PID settings given by [45] .

$$k_c = \frac{\tau_p + \frac{\tau_d}{2}}{k_p (\tau_d + \lambda)} \quad (25)$$

$$\tau_i = \tau_p + \frac{\tau_d}{2} \quad (26)$$

$$\tau_d = \frac{\tau_p \tau_d}{2\tau_p + \tau_d} \quad (27)$$

$$\tau_f = \frac{\lambda \tau_d}{2(\lambda + \tau_d)} \quad (28)$$

Above steps are repeated for perfect model and model mismatch and tuning parameters of IMC controller are adjusted. IMC based PID tuning advantage is the estimation of a single parameter  $\lambda$  instead of two three parameters in PID, the different parameters estimated for PID and IMC based PID are shown in Table1.

## 5. Example: FOPDT Process Model

In order to assess the practical utility of the above described advanced control algorithms, a series of simulation experiment have been conducted on a simple FOPDT process. For comparison purposes, a conventional PID controller is also designed using the Ziegler-Nichols method [8], [41].

The FOPDT process model is described by (29) and initially is assumed absence of plant model mismatch, inputs constraints or measured disturbances. The model selection is based on the fact that a FOPDT model represents any typical SISO chemical process given by (29).

$$G_c(s) = \frac{k_c}{\tau s + 1} e^{\theta s} \quad (29)$$

Consider the process model with following FOPDT Parameters with  $k=1; \theta=0.3$  and  $\tau=1$

$$G_c(s) = \frac{1}{s+1} e^{-0.3s} \quad (30)$$

The critical characteristics for the estimation of PID parameters are  $k_{cr} = 5.64$  and  $p_u = 1.083$ . The IMC-based PID parameters are estimated are shown in Table1. Selecting  $\lambda = 0.1$  and  $n = 1$ . The calculation of DMC gain matrix includes the following parameters; input weight  $\lambda = 0.1$ , output weight, control horizon  $M$  is 2, and prediction horizon ( $P$ ) 10.

**Table 1: IMC-Based PID and ZN Tuning Parameters of a FOPDT Process**

Controller	$K_p$	$T_I$	$T_D$	$\lambda/\theta$
ZN	3.31	0.5415	0.1353	--
IMC- PID	2.90	1.15	0.1304	>0.33

Fig 8-9, shows next simulation scenario includes constraints on the input and output variables.

$$-1 \leq u(t) \leq 1, -1 < y < y(t) < 1 \quad (31)$$

In the final simulation scenario a simple disturbance model described by (32) is also implemented, in order to study the capability of each controller in disturbance rejection with  $k=0.8$ ,  $\theta=0.1$  and  $\tau=1$

$$G_c(s) = \frac{0.8}{s+1} e^{-0.1s} \quad (32)$$

### 5.1. Simulation Results

Fig 3-5 shows the effect of tuning parameters selected by trial and error procedure and fig.6-10 shows the tuning parameters selected from [38].Which is derived and gives better results than trial and error procedure. With no disturbances and input constraints, the output response for the advanced control algorithms yields satisfactory step behavior with good set point tracking and smooth steady state approach. However, the response of the conventional PID seems to be rather disappointing fig.7, as it yields a large overshoot. Mainly concerning DMC and PID algorithms, the initial sharp increase of their control action signal may not be acceptable during a practical realization of the controller in an actual industrial plant. Fig.8, 9 shows the output response after the introduction of input constraints defined by (32). According to the results, both DMC and IMC-based PID controllers were unaffected by the input constraints as their constrained control action response has been within the constrained limits. Although the response of the conventional PID controller retained its large overshoot, the introduction of input constraints has optimized its smoothness. Finally DMC maintained its satisfactory performance, although the fact that its manipulated variable has been constrained the most Fig. 10,11 demonstrates the output responses of the process during the introduction of measured disturbances defined by (32). According to the results, DMC controller yields the most optimal response while IMC-PID controller sustains its performance. On the contrary IMC-based PID as well as the conventional PID yields a rather large overshoot. The performance measure are shown in table2.

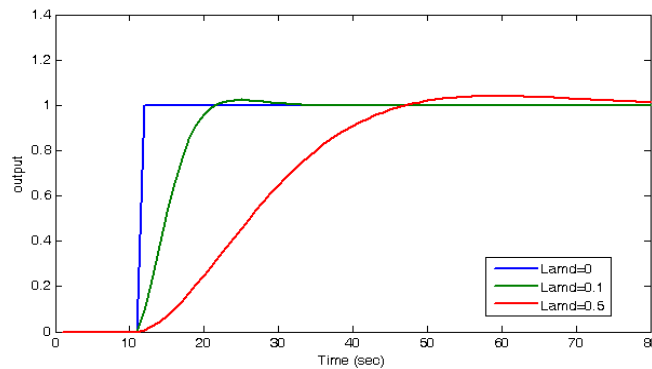

**Fig. 3 Importance of the Move Suppression Coefficient  $\lambda$ , =0, 0.1, 0.5 in Tuning of DMC with,  $M=2$ . $P=10$   $T=0.1$ .**

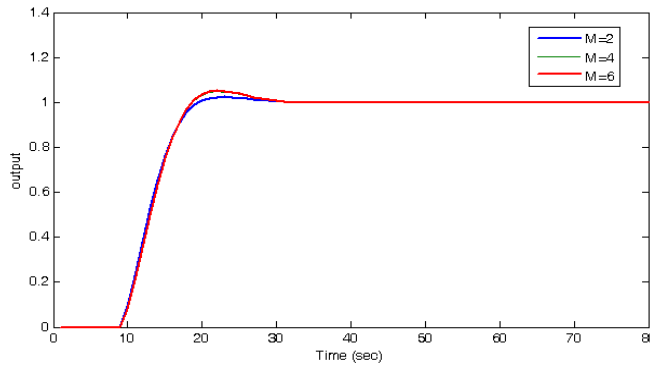

**Fig. 4 Importance of the Control Horizon  $M=2, 4, 6$ , in Tuning of DMC for  $P=10$   $T=0.1$ ,  $\lambda=0.1$**

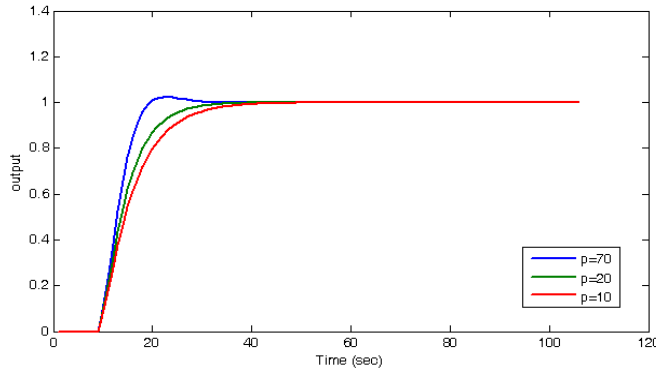

**Fig. 5 Importance of the Prediction Horizon,  $P=10, 20, 70$  in Tuning of DMC for  $M= 2$ ,  $T=0.1$ ,  $\lambda=0.1$**

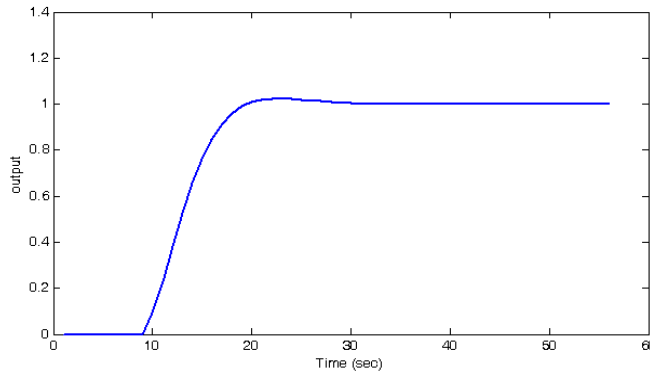

**Fig. 6 Response of DMC from Derived Tuning Parameters Control,  $M=2.P=4$ ,  $T=0.1$ ,  $\lambda=0.07$**

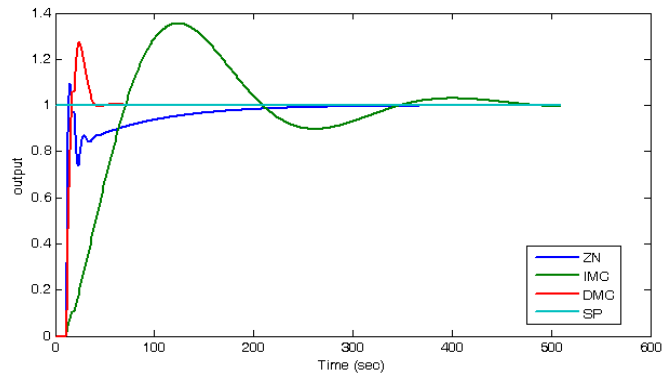

**Fig. 7 Unconstrained Responses with Three Controllers**

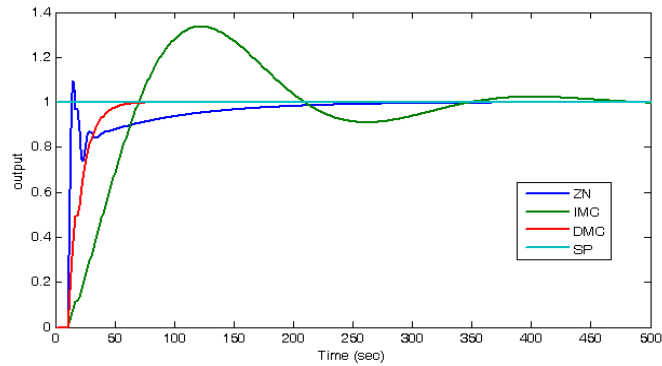

**Fig. 8 constrained Responses with Three Controllers.**

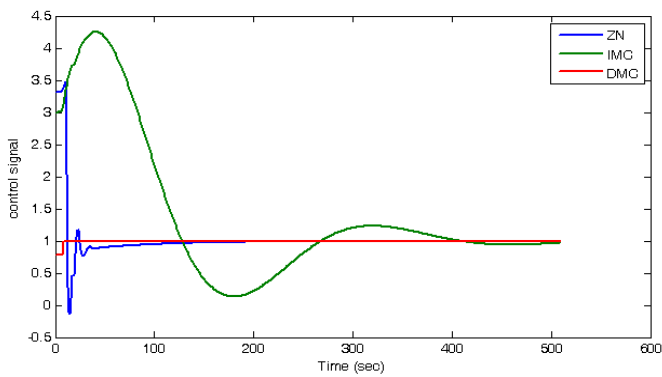

**Fig. 9 Constrained Control Action Responses with Three Controllers.**

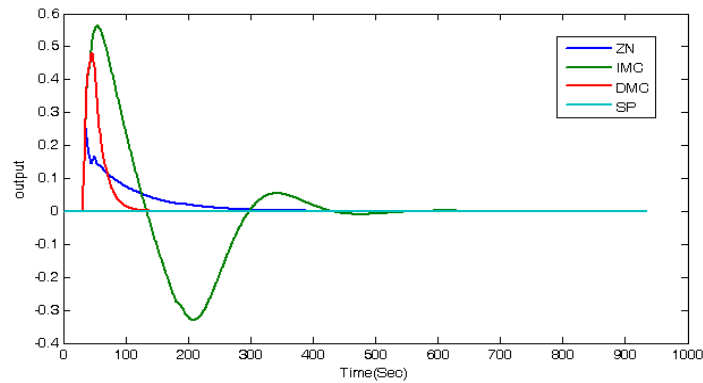

**Fig. 10 Responses with Measured Disturbance at, t=2 sec for Three Controllers.**

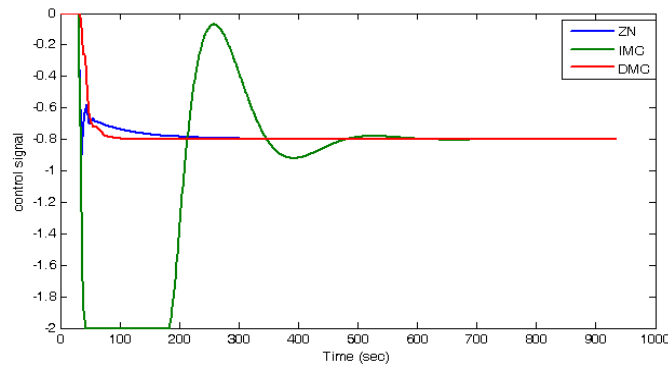

**Fig. 11 Control Action Response with Measured Disturbances at, t=2 sec. for Three Controllers.**

### 5.2. Performance Analysis

The performance of various controllers is shown in table 2, which shows that the DMC performs well then other controllers.

**Table 2**

Controller	$M_p(\%)$	$T_s(\text{sec})$	ISE	IAE
DMC	4	10	6.317e-012	3.99e-023
PID	5	18	0.001944	3.78e-006
PID with disturbance	5	20	0.009251	8.55e-007
PID-IMC Dist	4	21	9.40e-012	8.85e-024

## 6. Conclusion

It is observed from simulation experiment that DMC perform well then other controller and also shows the effect of tuning parameters. After implementation on the FOPDT process their step response was simulated using the Matlab/Simulink software and compared with the conventional PID controller which is tuned with Z-N method in various practical scenarios. Such scenarios include the implementation of input constraints or measured disturbances. From the simulations experiment result we conclude that advanced control DMC control algorithms perform satisfactory with good set point tracking and smooth steady state approach. They also sustain their robustness and performance during the introduction of input constraints and measured disturbance. Surprisingly, the step response of the conventional PID controller wasn't as optimal as it has been expected as its overshoot exceeds any typical specification limits.

## References

- [1] Åström, K. J.; Wittenmark, B. In *Computer Controlled Systems, Theory and Design*; Kailath, T., Ed.; Prentice-Hall Information and System Science Series; Prentice-Hall: Englewood Cliffs, NJ, 1984.
- [2] Callaghan, P. J.; Lee, P. L. An Experimental Investigation of Predictive Controller Design by Principal Component Analysis. *Chem. Eng. Res. Des.* **1988**, *66*, 345.
- [3] Camacho, E. F.; Bordons, C. *Model Predictive Control in the Process Industry, Advances in Industrial Control*; Springer-Verlag: London, 1995.
- [4] Clarke, D. W. *Advances in Model-Based Predictive Control*; Oxford University Press: New York, 1994.
- [5] Clarke, D. W.; Scattolini, R. Constrained Receding Horizon Predictive Control. *IEE Proc.* **1991**, *138* (4), 347.
- [6] Clarke, D. W.; Mohtadi, C.; Tuffs, P. S. Generalized Predictive Control-I. The Basic Algorithm. *Automatica* **1987a**, *23*, 137.
- [7] Clarke, D. W.; Mohtadi, C.; Tuffs, P. S. Generalized Predictive Control-II. Extensions and Interpretations. *Automatica* **1987b**, *23*, 149.
- [8] Cohen, G. H.; Coon, G. A. Theoretical Considerations of Retarded Control. *Trans. ASME* **1953**, *75*, 827.
- [9] Cutler, C. R. Dynamic Matrix Control, An Optimal Multivariable Control Algorithm with Constraints. Ph.D. Dissertation, University of Houston, Houston, TX, 1983.
- [10] Cutler, C. R.; Ramaker, D. L. Dynamic Matrix Control-A Computer Control Algorithm. *Proc. JACC*; San Francisco, CA, 1980.
- [11] Downs, J. J.; Vogel, E. F.; Williams, V. J. Tuning and Sensitivity Study for Model Predictive Control. *Am. Control Conf.* **1988**, *3*, 2357.
- [12] Farrell, R. J.; Polli, A. Comparison of Unconstrained Dynamic Matrix Control to Conventional Feedback Control for a First Order Model. *Adv. Instrum. Control* **1990**, *45* (2), 1033.
- [13] Franklin, G. F.; Powell, J. D. *Digital Control of Dynamic Systems*; Addison-Wesley Publishing Co.: Reading, MA, 1980.
- [14] García, C. E.; Morari, M. Internal Model Control. I. A Unifying Review and Some New Results. *Ind. Eng. Chem. Process Des. Dev.* **1982**, *21*, 308.
- [15] García, C. E.; Prett, D. M.; Morari, M. Model Predictive Control: Theory and Practice-A Survey. *Automatica* **1989a**, *25* (3), 335.
- [16] Hinde, R. F.; Cooper, D. J. Using Pattern Recognition in Controller Adaptation and Performance Evaluation. *Proc. Am. Control Conf., IEEE Publ.* **1993**, 74.
- [17] Hinde, R. F.; Cooper, D. J. A Unified Excitation and Performance Diagnostic Adaptive Control Framework. *AIChE J.* **1995**, *41*, 110.
- [18] Lalonde, A. M.; Cooper, D. J. Automated Design, Implementation and Adaptation of the Generalized Predictive Controller. *Proc. Am. Control Conf., IEEE Publ.* **1989**, 1840.
- [19] Lee, J. H.; Yu, Z. H. Tuning of Model Predictive Controllers for Robust Performance. *Comput. Chem. Eng.* **1994**, *18* (1), 15.
- [20] Lundström, P.; Lee, J. H.; Morari, M.; Skogestad, S. Limitations of Dynamic Matrix Control. *Comput. Chem. Eng.* **1995**, *19* (4), 409.

- [21] Marchetti, J. L.; Mellichamp, D. A.; Seborg, D. E. Predictive Control Based on Discrete Convolution Models. *Ind. Eng. Chem. Process Des. Dev.* **1983**, *22*, 488.
- [22] Maurath, P. R.; Mellichamp, D. A.; Seborg, D. E. Predictive Controller Design by Principal Component Analysis. *Proc. Amer. Cont. Conf., IEEE Publications*, **1985**, 1059.
- [23] Maurath, P. R.; Mellichamp, D. A.; Seborg, D. E. Predictive Controller Design for Single Input/Single Output Systems. *Ind. Eng. Chem. Res.* **1988a**, *27*, 956.
- [24] Maurath, P. R.; Laub, A. J.; Mellichamp, D. A.; Seborg, D. E. Predictive Controller Design by Principal Components Analysis. *Ind. Eng. Chem. Res.* **1988b**, *27*, 1204.
- [25] McIntosh, A. R. Performance and Tuning of Adaptive Generalized Predictive Control. M.Sc. Thesis, University of Alberta, 1988.
- [26] McIntosh, A. R.; Shah, S. L.; Fisher, D. G. Analysis and Tuning of Adaptive Generalized Predictive Control. *Can. J. Chem. Eng.* **1991**, *69*, 97.
- [27] McIntosh, A. R.; Fisher, D. G.; Shah, S. L. Performance Adaptive Control: General Structure and a Case Study. *J. Process Control* **1992**, *2* (4), 213. Middleton, R. H. Tradeoffs in Linear Control System Design. *Automatica* **1991**, *27*, 281.
- [28] Morari, M.; Lee, J. H. Model Predictive Control: The Good, the Bad and the Ugly. In *Proc. Chem. Process Control Conf., CPC IV*, Fourth International Conference on Chemical Process Control; Arkun, Y., Ray, W. H., Eds.; Elsevier: Amsterdam, Holland, 1991.
- [29] Muske, K. R.; Rawlings, J. B. Model Predictive Control with Linear Models. *AIChE J.* **1993**, *39*, 262.
- [30] MPrett, D. M.; Garcí'a, C. E. *Fundamental Process Control*; Butterworths: Boston, MA, 1988.
- [31] Prett, D. M., & Gillette, R. D. (1980). Optimization and constrained multivariable control of a catalytic cracking unit. In Proceedings of the joint automatic control conference
- [32] Ohshima, M.; Hashimoto, I.; Takamatsu, T.; Ohno, H. Robust Stability of Model Predictive Control (MPC). *Int. Chem. Eng.* **1991**, *31* (1), 119.
- [33] Qin, J. S.; Badgwell, T. A. An Overview of Industrial Model Predictive Control Technology. *Prepr. Proc. Chem. Process Control Conf., CPC V*; Tahoe City, CA, 1996.
- [34] Rawlings, J.; Muske, K. The Stability of Constrained Receding Horizon Control. *IEEE Trans. Autom. Control* **1993**, *38*, 1512.
- [35] Richalet, J. Industrial Applications of Model Based Predictive Control. *Automatica* **1993**, *29* (5), 1251.
- [36] Richalet, J.; Rault, A.; Testud, J. L.; Papon, J. Algorithmic Control of Industrial Processes. 4th IFAC Symposium on Identification and System Parameter Estimation; Tbilisi, USSR, 1976.
- [37] Ricker, N. L. Model Predictive Control: State of the Art. In *Proc. Chem. Process Control Conf., CPC IV*, Fourth International Conference on Chemical Process Control; Arkun, Y., Ray, W.H., Eds.; Elsevier: Amsterdam, Holland, 1991.
- [38] Rahul Shridhar and Douglas J. Cooper, A Tuning Strategy for Unconstrained SISO Model Predictive Control, *Ind. Eng. Chem. Res.* 1997, *36*, 729-746 .
- [39] Richalet, J., Rault, A., L. Testud, J., and Papon, J. *Model Predictive Heuristic Control*. *Automatica*, *14*:413, 1978.
- [40] Rivera, E. D. *Internal Model Control: A Comprehensive View*. Arizona State University, Arizona, 1999.
- [41] Ziegler, J., C., Nichols, N., B., *Optimum Settings for Automatic Controllers*. Trans. A.S.M.E. vol. 64., 1942.
- [42] Coughanour, D. *Process Systems Analysis & Control* NY, McGraw-Hill c1991 Chemical Engineering Series, 1991
- [43] Bequette, B. W., *Process Control: Modelling, Design and Simulation*. Prentice Hall, Upper Saddle River, NJ, 2003.
- [44] Morari, M., & Zafiriou, F., *Robust Process Control*. Prentice Hall, Englewood Cliffs NJ, 1989.